

Sample Circuit Diagrams (with COVID-19 considerations) – Balance 3 Lesson Plan



These sample circuits for Skate Canada Balance 3 lesson plan have been created to include COVID-19 considerations. They serve as a sample of how to modify circuits with physical distancing protocols while running CanSkate sessions during COVID-19. Full lesson plans, progressions and teaching tools are found in the [CanSkate Manual \(Lesson Plans\)](#).

All CanSkate sessions must adhere to the '[Program Requirements and Delivery Standards - CanSkate WITH COVID-19 CONSIDERATIONS](#)'.

Note: All circuits use 3-station format, with a maximum of 12 skaters per group. Balance and Control should use the stations with the hockey circles, Agility in the middle. Be mindful that if the middle station (between the blue lines) is smaller than the outer stations, lanes for the middle circuit (Agility) should be on the blue line to maximize ice usage.

We have outlined items you will find in the circuit and recommendations to maximize circuit use.

Spacing	Circuit lanes must comply with physical distancing requirements (2m apart). Each circuit diagram outlines a “Coach/PA” area where coaches and PAs can move freely to assist skaters on the circuit. This space can be used to pull skaters off the circuit to work one-on-one and to travel between skills. The space can also be used for skaters to pass slower skaters.
Starting positions	<p>Each circuit identifies starting points for up to 12 skaters. This tool can be used to help space skaters at the start of the circuit. Once moving, remind skaters to abide by physical distancing protocols and use passing when behind a slower skater.</p> <p>Skaters will need guidance to get used to the drawings/signs on the ice as they are starting from different positions.</p> <p>Options to help with the transition:</p> <ol style="list-style-type: none"> 1. Assign each skater a number 1 to 12 to identify their starting point <ol style="list-style-type: none"> a. Pictures could also be used to identify their starting point (animals, houses, emojis, etc.) b. Give each skater a picture of their number/picture on their name tag or a sticker on their jacket. 2. Use more PAs for the first couple weeks to help skaters become accustomed to the drawings and finding their place. 3. Consider assigning a PA to a small group of skaters (3 or 4) to take them through the circuit from their assigned starting positions for the first round. <ol style="list-style-type: none"> a. Focus on the key words for each skill, spacing, how to pass and general awareness in the circuit.

<p>Assisted Skills</p>	<p>Try using the boards to aid with assisted skills. Draw boxes at the boards. Skaters use the boards to keep balance while they attempt the new skill. Consider designating a PA to sanitize boards after use.</p> <p>The following diagrams are used in the sample Balance circuits and can be used as stationary skills or using the boards for assistance.</p>	
		<p>Stationary 1-ft stand, or boards assisted 1-foot stand</p>
		<p>Stationary V position, or boards assisted V position</p>
<p>Progressions</p>	<p>Be creative with your progressions! Engaging skaters to try new things and work on progressions to skills will be challenging without the ability to use hands-on teaching.</p> <p>Try using the boards to aid with assisted skills and progressions.</p> <p>For example: Boards assisted inside spread eagle</p>	
		<p>Try using the boards to assist skaters with the position for inside spread eagles.</p>
<p>Skater Passing</p>	<p>Skaters should be encouraged to pass if they are met with a slower skater. Skaters can use the space around their lane to pass. Encourage making a wide circle around the skater.</p> <p>For example: Try using the familiar concept of cars passing on a highway.</p>	

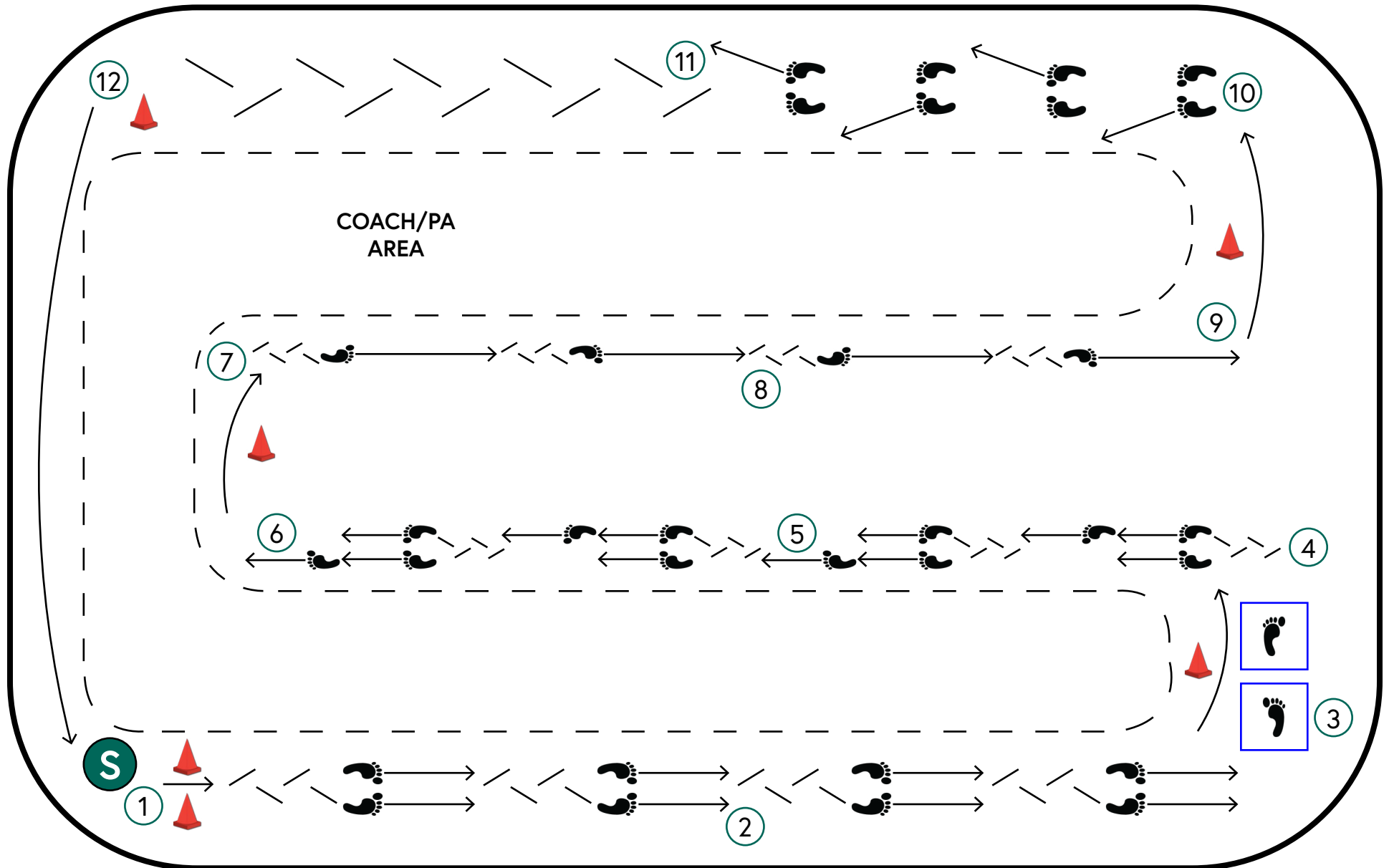

CanSkate (B3 1-2) Diagram with COVID-19 CONSIDERATIONS

- Designed by Patinage Québec and Skate Ontario and endorsed by Skate Canada
- Created to assist clubs/skating schools to implement recommended COVID-19 safety protocols

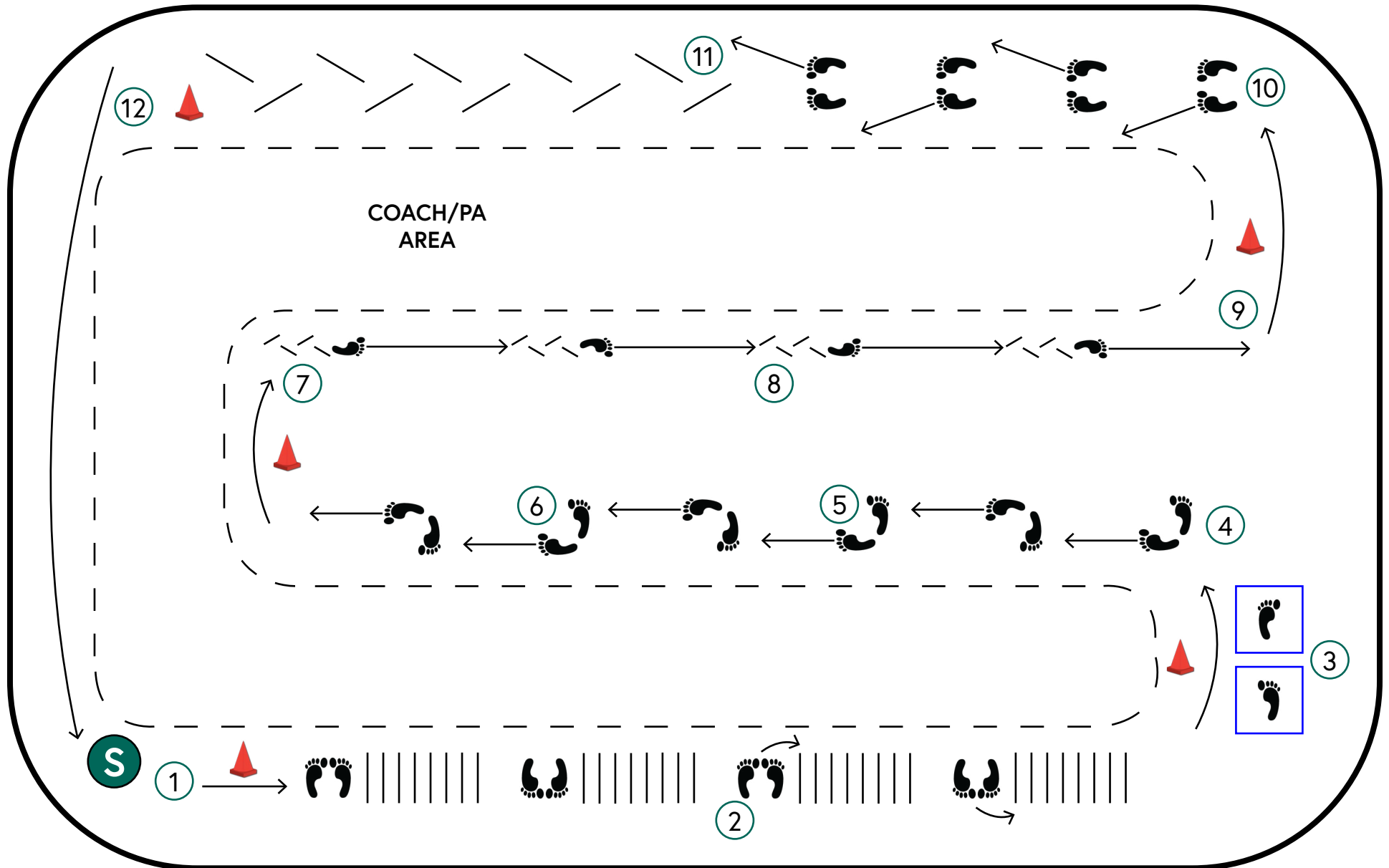

CanSkate (B3 2-3) Diagram with COVID-19 CONSIDERATIONS

- Designed by Patinage Québec and Skate Ontario and endorsed by Skate Canada
- Created to assist clubs/skating schools to implement recommended COVID-19 safety protocols



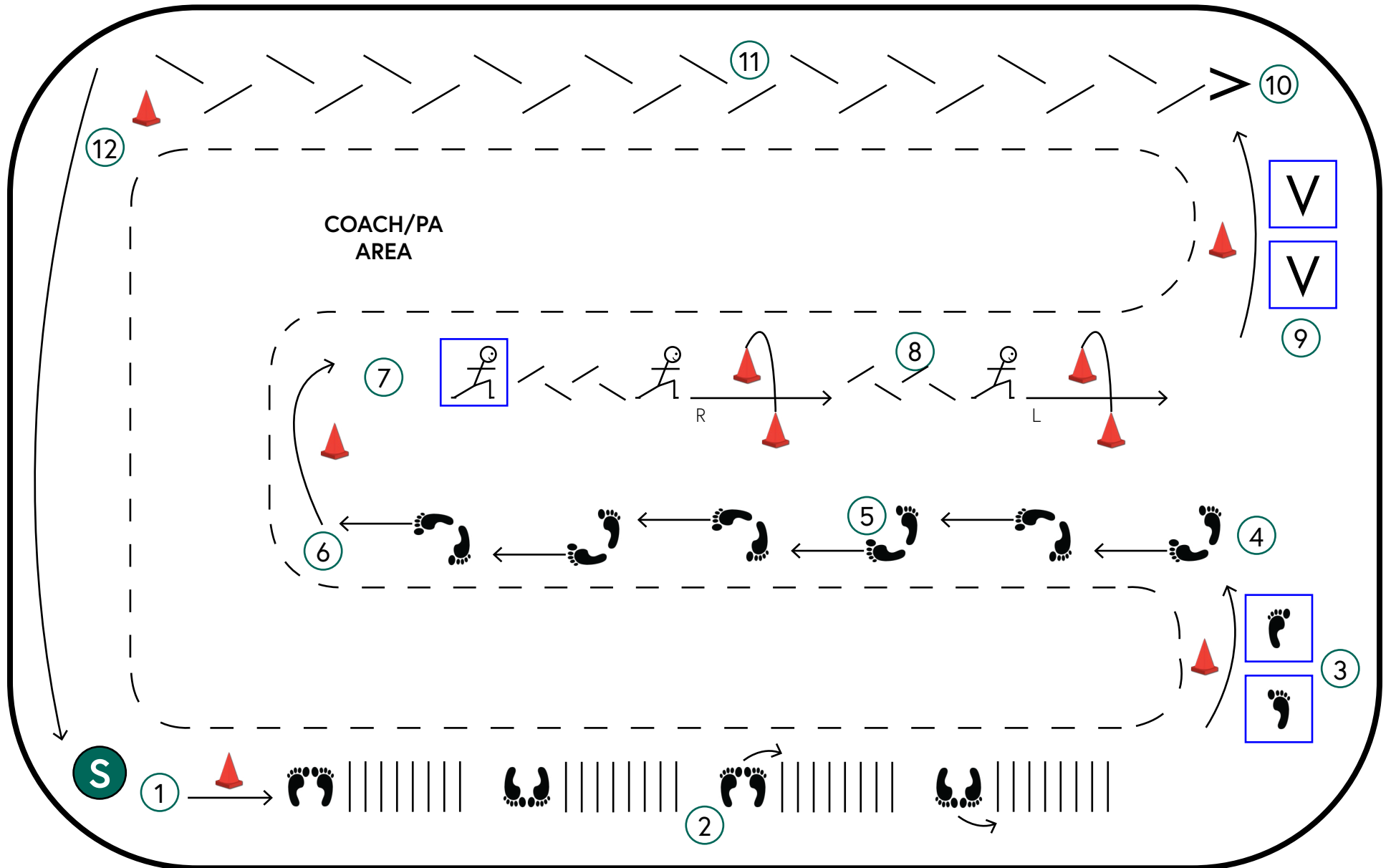

CanSkate (B3 3-4) Diagram with COVID-19 CONSIDERATIONS

- Designed by Patinage Québec and Skate Ontario and endorsed by Skate Canada
- Created to assist clubs/skating schools to implement recommended COVID-19 safety protocols

CanSkate (B3 4-5) Circuit with COVID-19 CONSIDERATIONS

Sep 2020

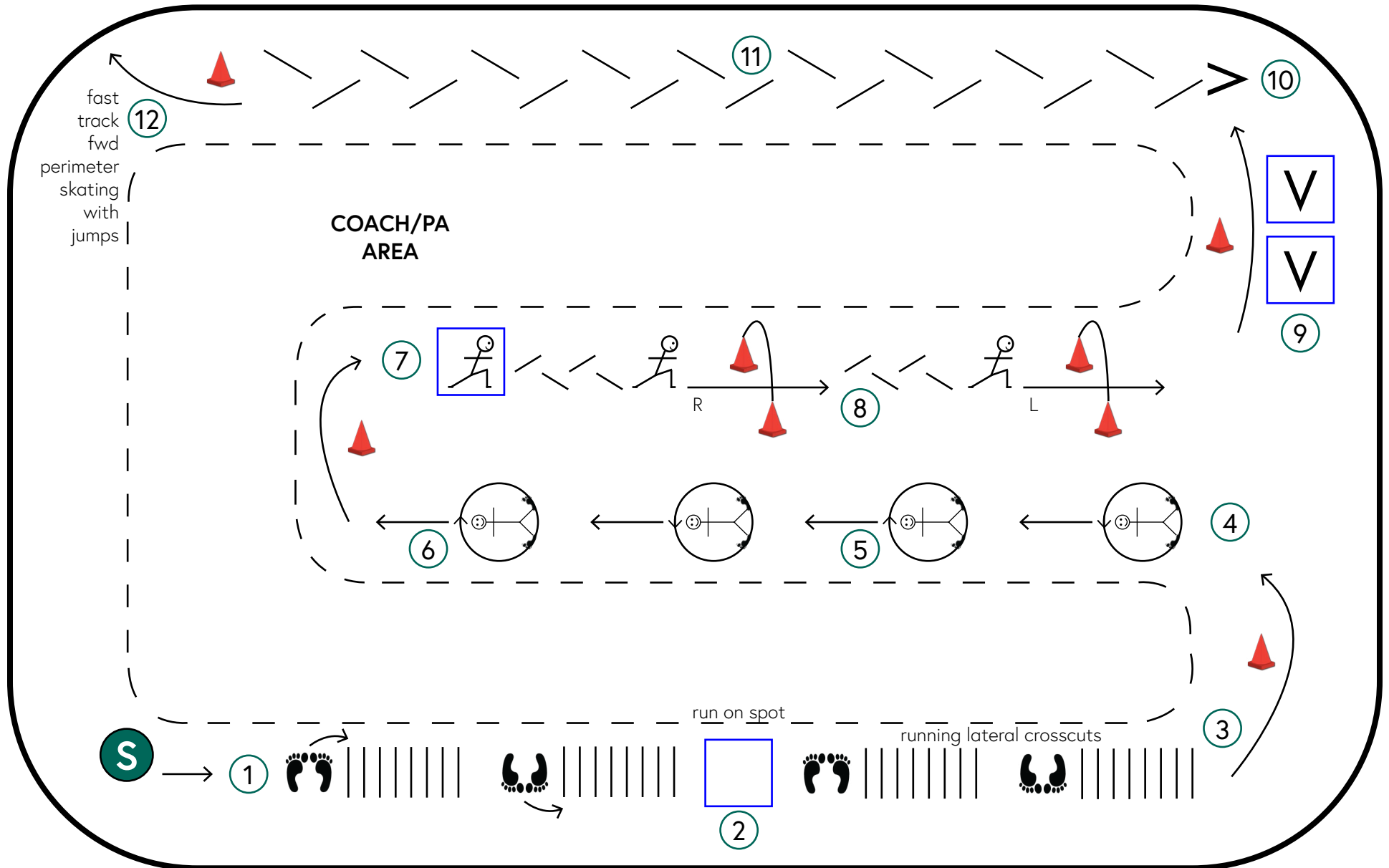

CanSkate (B3 4-5) Diagram with COVID-19 CONSIDERATIONS

- Designed by Patinage Québec and Skate Ontario and endorsed by Skate Canada
- Created to assist clubs/skating schools to implement recommended COVID-19 safety protocols



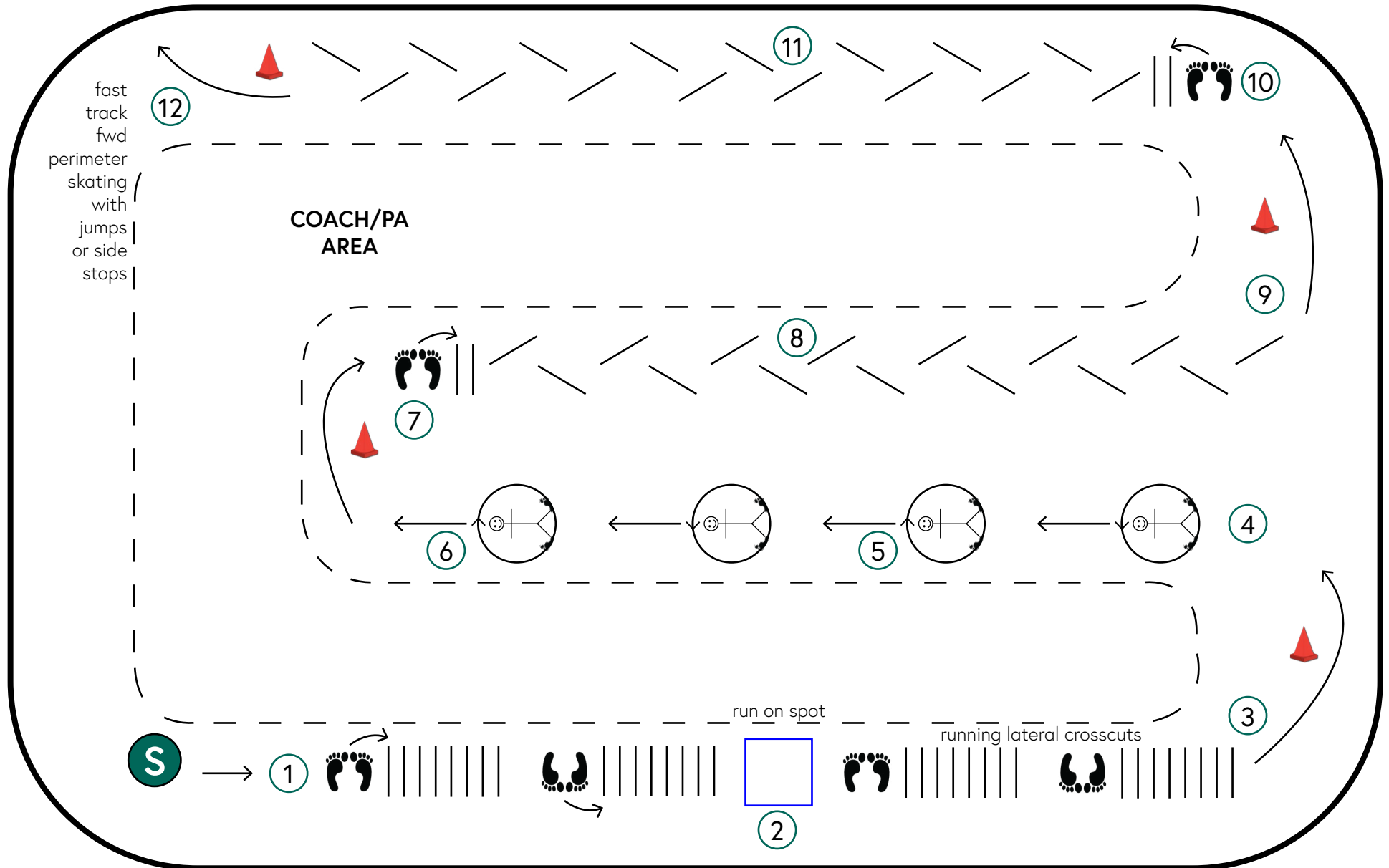

CanSkate (B3 5-6) Diagram with COVID-19 CONSIDERATIONS

- Designed by Patinage Québec and Skate Ontario and endorsed by Skate Canada
- Created to assist clubs/skating schools to implement recommended COVID-19 safety protocols

